

VOLUMEN (l)
VOLUMEN (l)





MAX. OBREMENITEV (Kg)
MAX. OBTEREČENJE (Kg)

OBREMENITEV TAL (Kg/m²)
OBTEREČENJE PODA (Kg/m²)

180



335

305

-  - Prostor za el. vodnik 3 x 2,5 mm², dolžine cca 1m.
-  - Mjesto za el. vodnik 3 x 2,5 mm², dužine cca 1m.
-  - Prostor za el. vodnik 1 x 6 mm² za ozemljitev, dolžine cca 1,5m.
-  - Mjesto za el. vodnik 1 x 6 mm² za ozemljenje, dužine cca 1,5m.



- Priklop tople in hladne vode 1/2" min 0,2 Mpa, max 0,4 Mpa
- Priključak tople i hladne vode 1/2" min 0,2 Mpa, max 0,4 Mpa

-  - Prostor za odtok ø 50 mm
-  - Mjesto za odtok ø 50 mm

-  - Opcija-obloga
-  - Opcija-obloga

PREDLOG VGRADNJE
PRIJEDLOG UGRADNJE

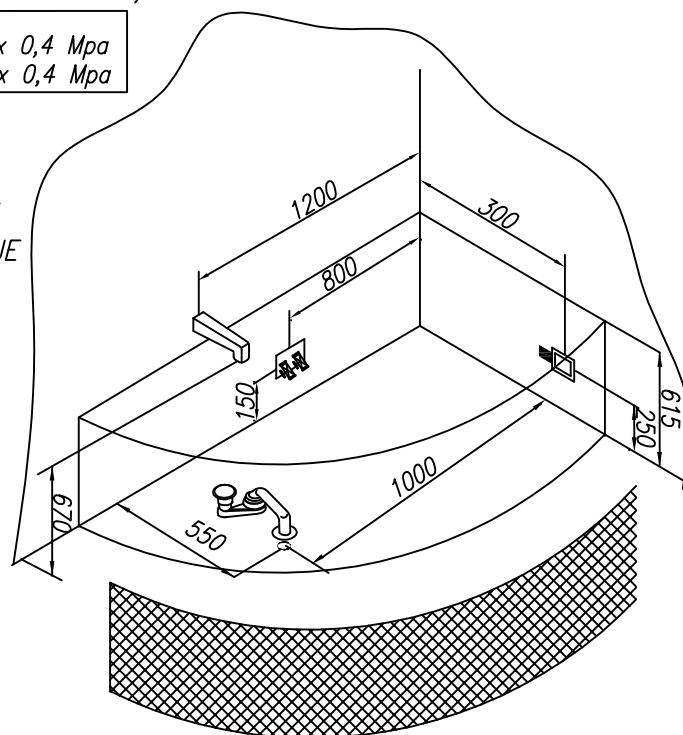

Preporučena prelivna garnitura Preporuka prelivne garniture	PAL 450
Preporučila za vgradnjo kadi brez obloge Preporuka za ugradnjo kade bez obloge	Nr. MK 02
Preporučila za montažo kadi z oblogo Preporuka za ugradnjo kade sa oblogom	Nr. MK 01
Opcija podnožja kadi za vgradnjo Varianta postolja za kade bez obloge	Nr. MK 05 PKK 501
Opcija podnožja kadi z oblogo Varianta postolja za kade sa oblogom	Nr. MK 16 CAM 150-180