

PREDINSTALACIJA  
PREDINSTALACIJA

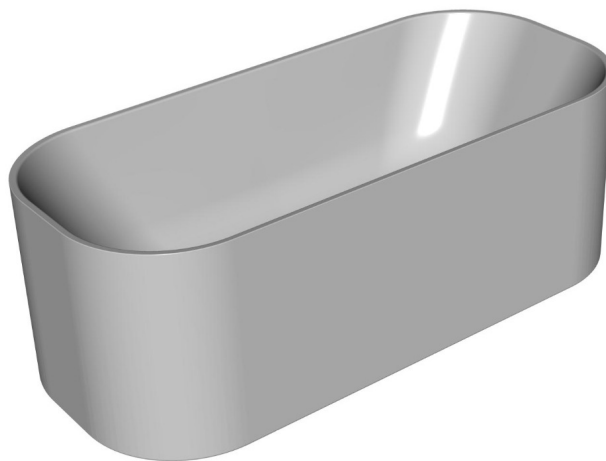
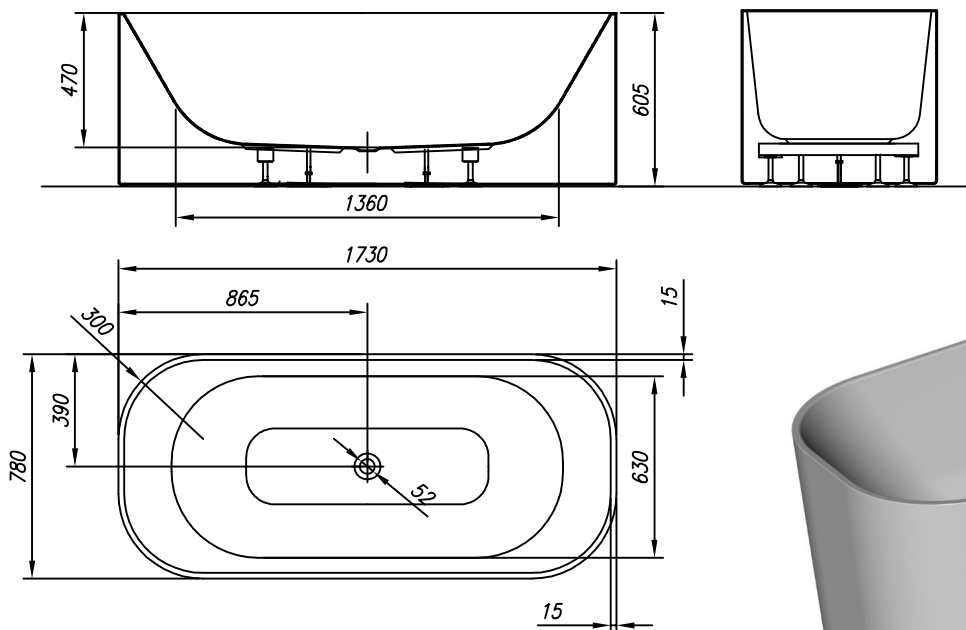
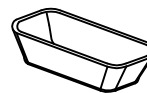

VOLUMEN (l)  
VOLUMEN (l)

MAX. OBREMENITEV (Kg)  
MAX. OBTEREČENJE (Kg)

OBREMENITEV TAL (Kg/m<sup>2</sup>)  
OBTEREČENJE PODA (Kg/m<sup>2</sup>)

285

450

355

- - Prostor za odtok  $\varnothing$  50 mm
- Mjesto za odtok  $\varnothing$  50 mm

PREDLOG VGRADNJE  
PRIJEDLOG UGRADNJE

