

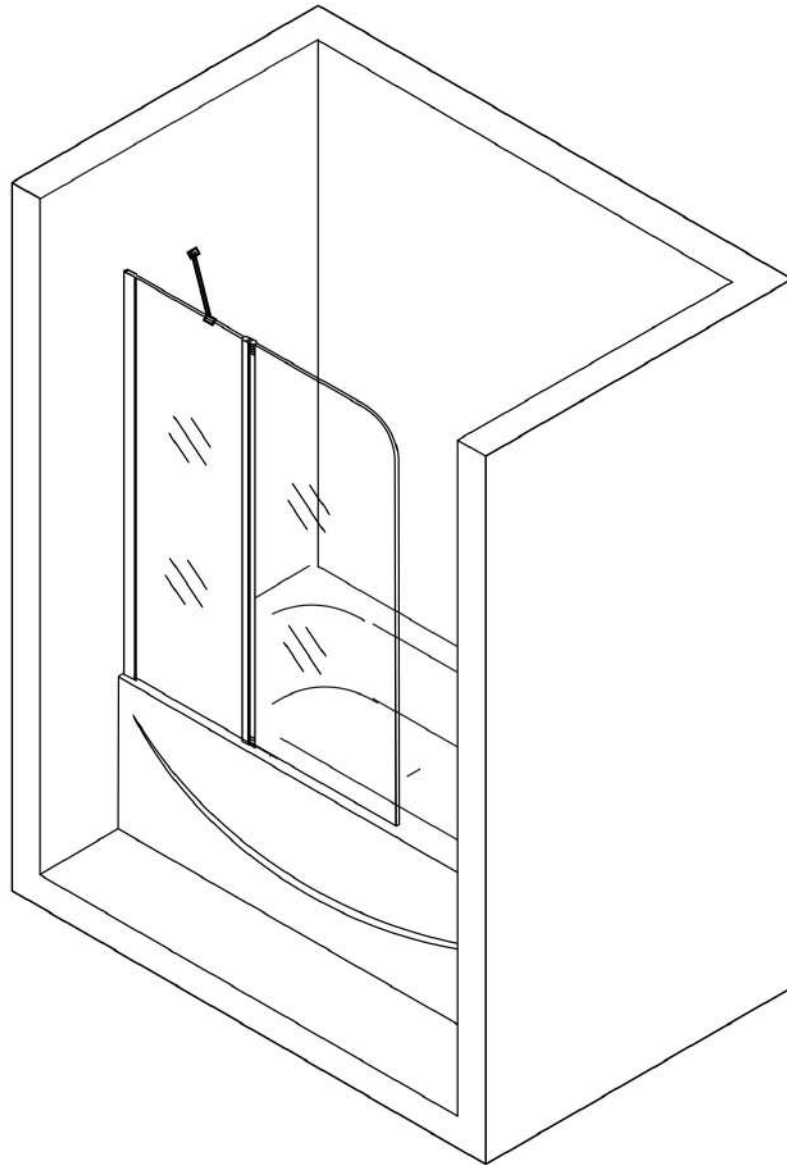











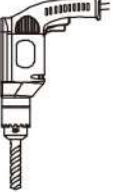

F03
H=1300 W=1200



1

						
A1	A2	A3	A4	A5	A6	A7
						
4	M4*25=4	M4*10=2	2	M4*25=2	1	1

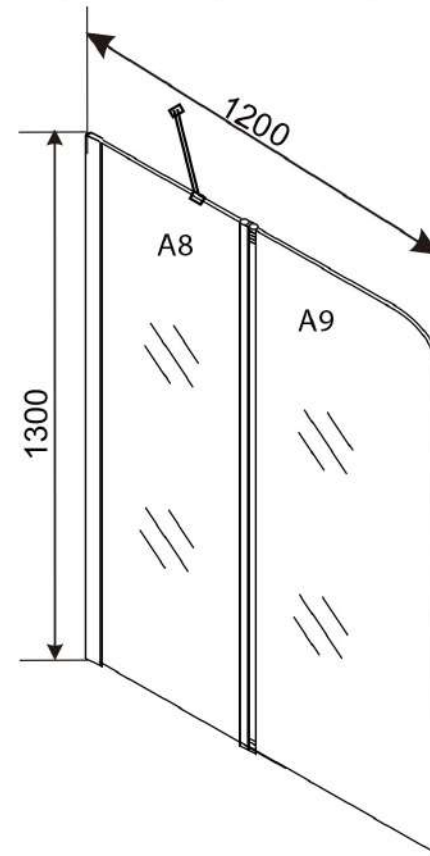

2

