

Installation Manual

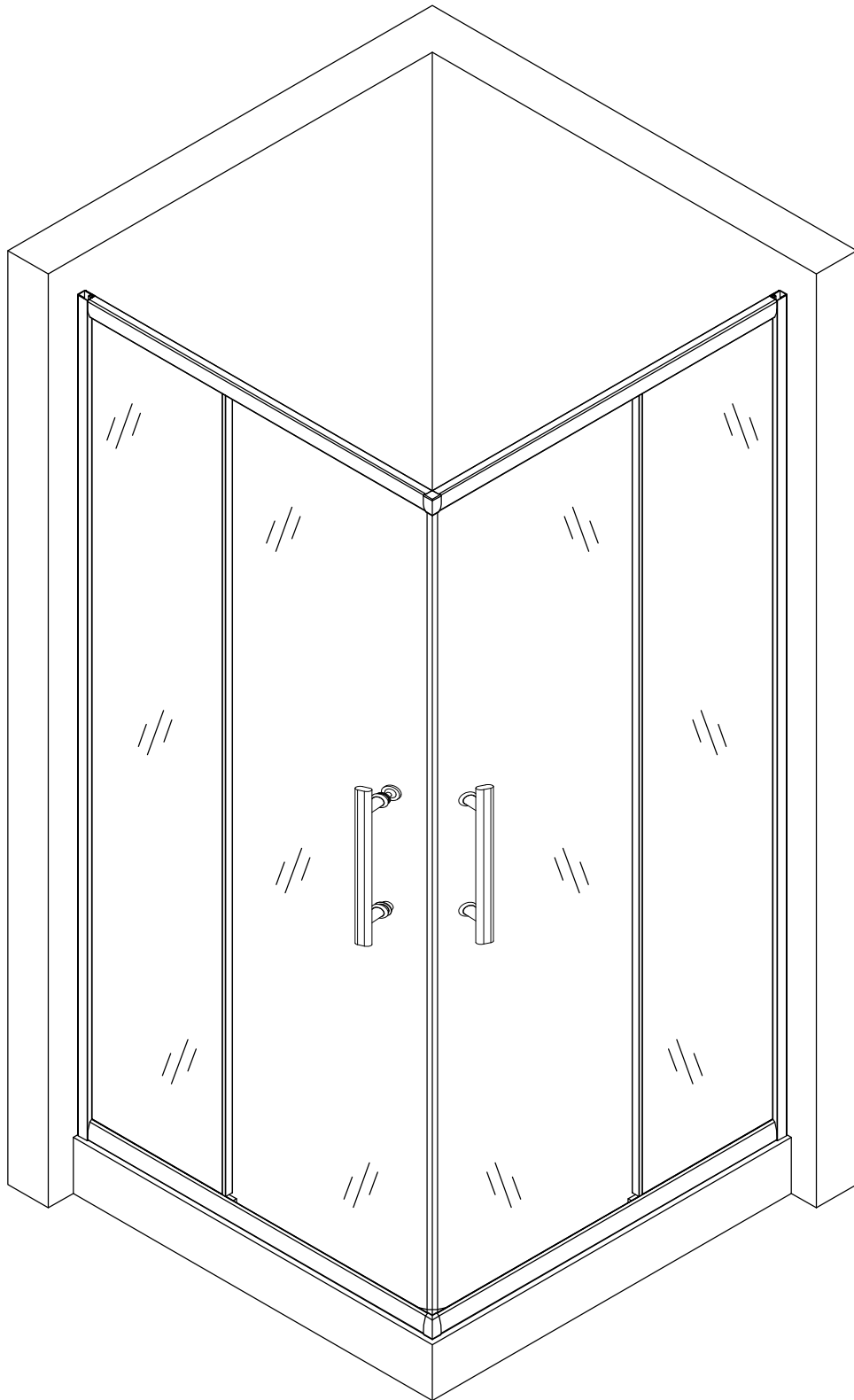







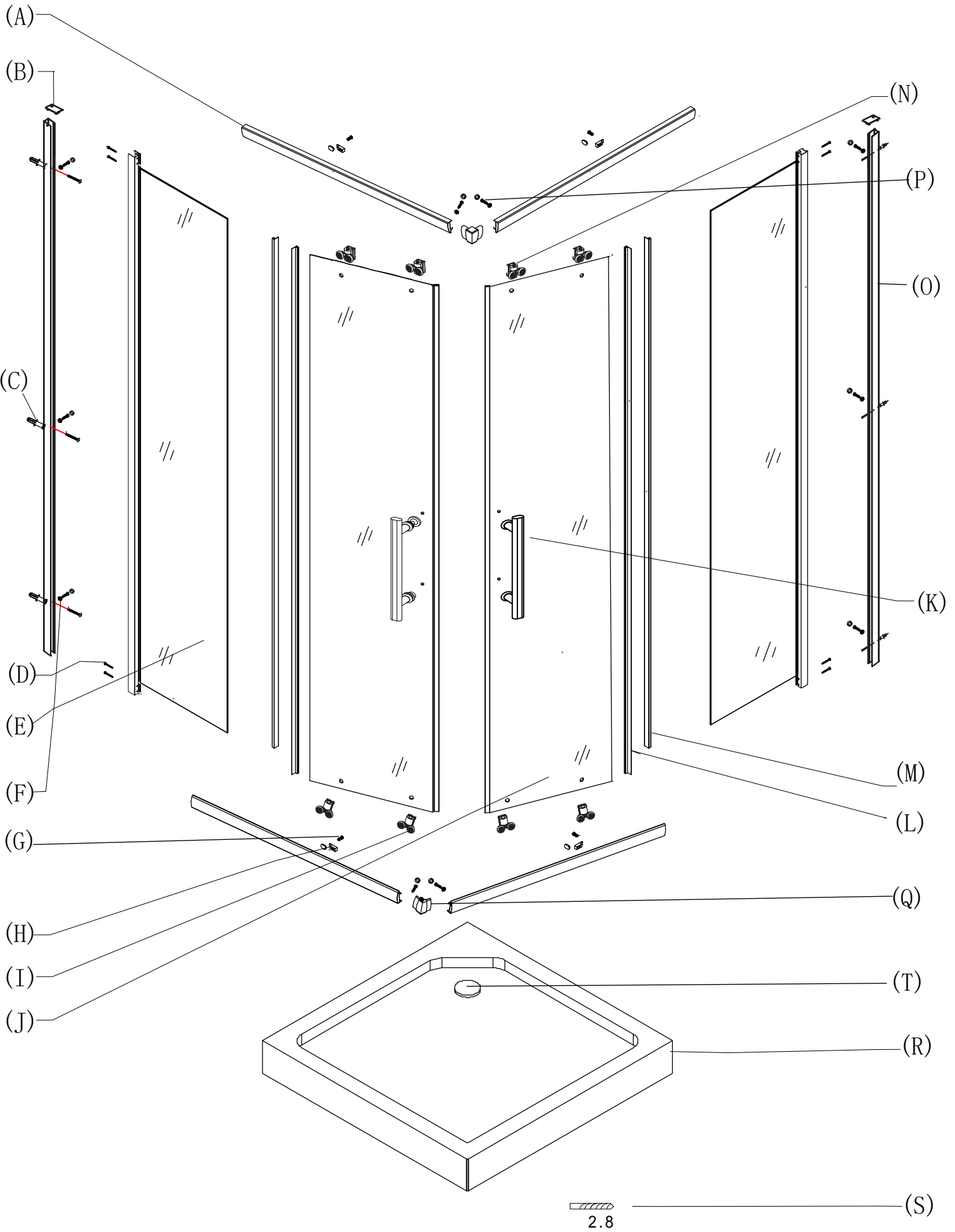

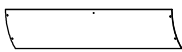







MODEL: ESD-8024 / ESD-8034

SIZE: 900*900*2000MM

1000*1000*2000MM

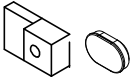
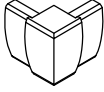

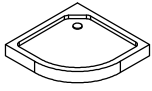
A		4	J		2	S		1
B		2	K		2	T		1
C		6	L		2			
D		14	M		2			
E		2	N		4			
F		10	O		2			
G		10	P		4			
H		4	Q		2			
I		4	R		1			

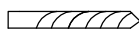
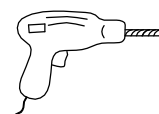
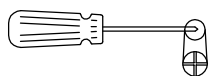
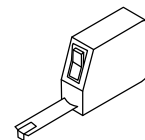
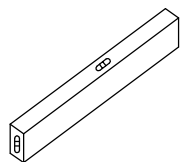

Ø6

